

ENSTO

Oprawy oświetleniowe do szynoprzewodów



Better life.
With electricity.

MAKKEISET
PÄHKINÄT
SUKLAATIT

14

IRTOMAKEISET
irtopähkinät
pähkinät

15
PÄHKINÄT
SUKLAATIT
TUOSTOKASVIT

Jäävuori-
salaatti
1. lk Hollanti
122
3 65
Kilo

K CITYMARKET
Paprika
Punainen
1. lk. Hollanti
107
2 99
Kilo

K CITYMARKET
Paprika
Keltainen
1. lk. Hollanti
198
3 80
Kilo

PIKKA
Pikka
Paprika
300g 2kpl
189



Spis trešći

Stage 4

Arena 6

Diva 10

Club 14

Play 18

Mini Play 22

Stage

LED

Energooszczędna oprawa do oświetlenia punktowego.





Konstrukcja

- › Obudowa: malowane proszkowo aluminium
- › Kolory obudowy: biały i czarny
- › Moc: 42W i 55W
- › Kąt rozsyłu:
 - 30°
 - 40°
 - 50°
- › Strumień świetlny: patrz tabela
- › 3000 K, 4000 K, Ra>90
- › MacAdams 2-SDCM
- › Żywotność modułu LED: 50 000h (L80B10)

Montaż

- › Szynoprzewód 3-fazowy
- › Adapter GA69

Na zamówienie

- › Obudowa w kolorze srebrnym
- › DALI
- › Inne kąty rozsyłu
- › Inne temperatury barwowe, strumienie świetlne oraz współczynniki oddawania barw
- › Specjalne kolory do oświetlania artykułów spożywczych

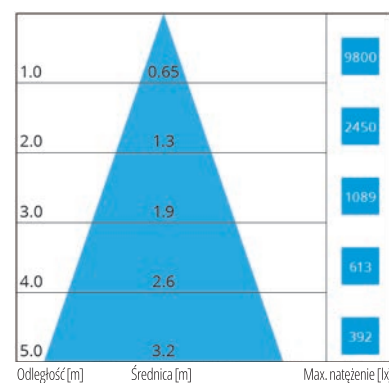
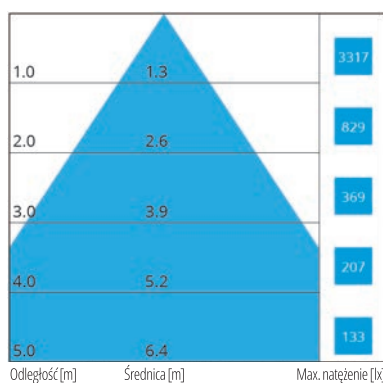
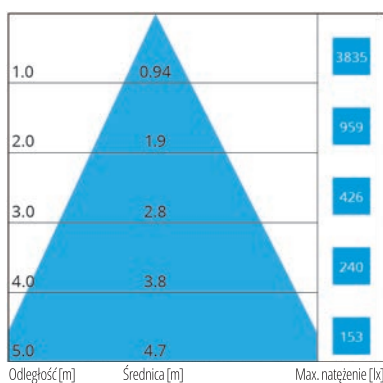
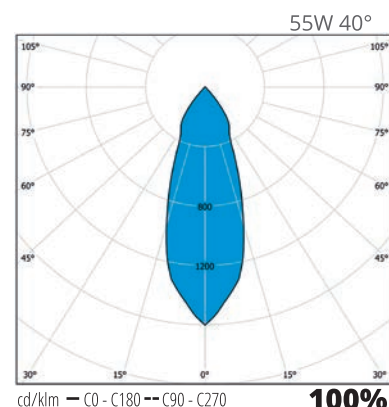
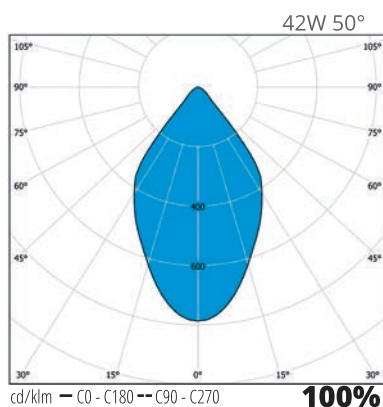
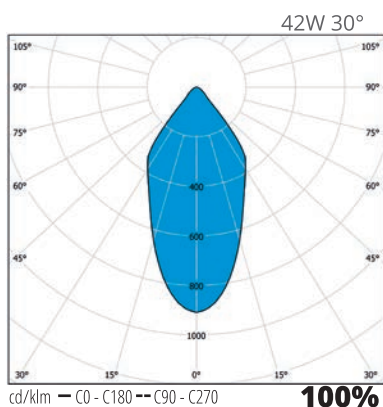
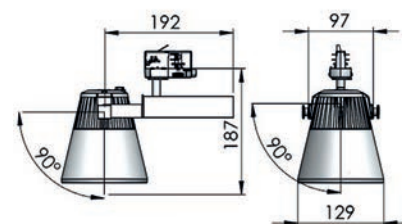

| EAN | Typ | Nazwa produktu | Źródło | Kolor | Kg | Kąt rozsyłu | Moc | Strumień świetlny |
|--------------|-------------|---------------------------|--------|--------|------|-------------|-----|-------------------|
| Stage | | | | | | | | |
| 42 604 79 | ST33FL930WH | ST33FL930WH 3300LM FL WH | LED | Biały | 1,12 | 30° | 42W | 3300 lm |
| 42 604 81 | ST33FL930BL | ST33FL930BL 3300LM FL BL | LED | Czarny | 1,12 | 30° | 42W | 3300 lm |
| 42 604 83 | ST34WF930WH | ST34WF930WH 3375LM WFL WH | LED | Biały | 1,12 | 50° | 42W | 3375 lm |
| 42 604 84 | ST34WF930BL | ST34WF930BL 3375LM WFL BL | LED | Czarny | 1,12 | 50° | 42W | 3375 lm |
| 42 604 87 | ST50FL930BL | ST50FL930BL 5000LM FL BL | LED | Czarny | 1,22 | 40° | 55W | 5000 lm |
| 42 604 89 | ST50FL930WH | ST50FL930WH 5000LM FL WH | LED | Biały | 1,22 | 40° | 55W | 5000 lm |

Arena

LED

Energooszczędna oprawa do oświetlenia punktowego.



Konstrukcja

- › Obudowa: malowane proszkowo aluminium
- › Kolory obudowy: biały i czarny
- › Moc: 42W i 55W
- › Kąt rozsyłu:
 - 30° i 50° (42W)
 - 40° i 60° (55W)
- › Strumień świetlny: patrz tabela
- › 3000 K, 4000K, Ra>80 i Ra>90
- › MacAdams 2-SDCM
- › Żywotność modułu LED: 50 000h (L80B10)

Montaż

- › Szynoprzewód 3-fazowy
- › Adapter GA69

Na zamówienie

- › Obudowa w kolorze srebrnym
- › DALI
- › Inne kąty rozsyłu
- › Inne temperatury barwowe, strumienie świetlne oraz współczynniki oddawania barw
- › Specjalne kolory do oświetlania artykułów spożywczych

| EAN | Typ | Nazwa produktu | Źródło | Kolor | Kg | Kąt rozsyłu | Moc | Strumień świetlny |
|-----------|-------------|---------------------------|--------|--------|------|-------------|-----|-------------------|
| Arena | | | | | | | | |
| 42 604 90 | AR39FL830WH | AR39FL830WH 3900LM FL WH | LED | Biały | 1,35 | 30° | 42W | 3900 lm |
| 42 604 91 | AR39FL830BL | AR39FL830BL 3900LM FL BL | LED | Czarny | 1,35 | 30° | 42W | 3900 lm |
| 42 604 93 | AR40WF830WH | AR40WF830WH 3975LM WFL WH | LED | Biały | 1,35 | 50° | 42W | 3975 lm |
| | AR40WF840WH | AR40WF840WH 4100LM WFL WH | LED | Biały | 1,35 | 50° | 42W | 4100 lm |
| 42 604 95 | AR40WF830BL | AR40WF830BL 3975LM WFL BL | LED | Czarny | 1,35 | 50° | 42W | 3975 lm |
| 42 604 96 | AR33FL930WH | AR33FL930WH 3300LM FL WH | LED | Biały | 1,35 | 30° | 42W | 3300 lm |
| 42 604 97 | AR33FL930BL | AR33FL930BL 3300LM FL BL | LED | Czarny | 1,35 | 30° | 42W | 3300 lm |
| 42 604 99 | AR34WF930WH | AR34WF930WH 3375LM WFL WH | LED | Biały | 1,35 | 50° | 42W | 3375 lm |
| 42 605 01 | AR34WF930BL | AR34WF930BL 3375LM WFL BL | LED | Czarny | 1,35 | 50° | 42W | 3375 lm |
| 42 605 02 | AR59FL830WH | AR59FL830WH 5850LM FL WH | LED | Biały | 1,45 | 40° | 55W | 5850 lm |
| 42 605 03 | AR59FL830BL | AR59FL830BL 5850LM FL BL | LED | Czarny | 1,45 | 40° | 55W | 5850 lm |
| 42 605 05 | AR59WF830WH | AR59WF830WH 5875LM WFL WH | LED | Biały | 1,45 | 60° | 55W | 5875 lm |
| 42 605 07 | AR59WF830BL | AR59WF830BL 5875LM WFL BL | LED | Czarny | 1,45 | 60° | 55W | 5875 lm |
| 42 605 08 | AR50FL930WH | AR50FL930WH 5000LM FL WH | LED | Biały | 1,45 | 40° | 55W | 5000 lm |
| 42 605 10 | AR50FL930BL | AR50FL930BL 5000LM FL BL | LED | Czarny | 1,45 | 40° | 55W | 5000 lm |
| 42 605 11 | AR50WF930WH | AR50WF930WH 5025LM WFL WH | LED | Biały | 1,45 | 60° | 55W | 5025 lm |
| 42 605 12 | AR50WF930BL | AR50WF930BL 5025LM WFL BL | LED | Czarny | 1,45 | 60° | 55W | 5025 lm |

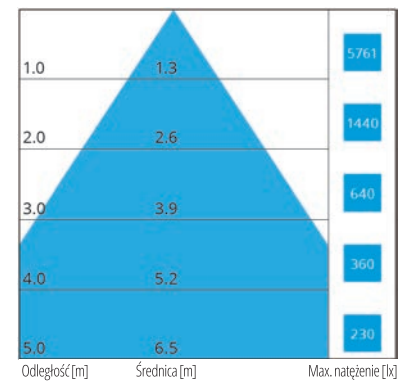
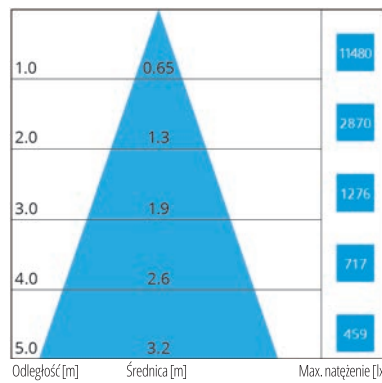
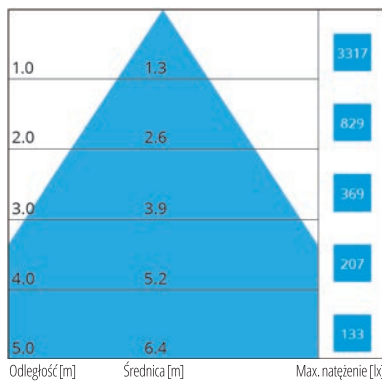
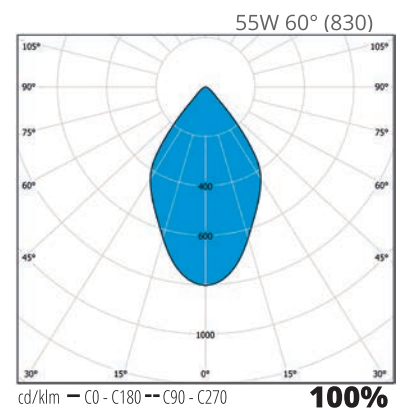
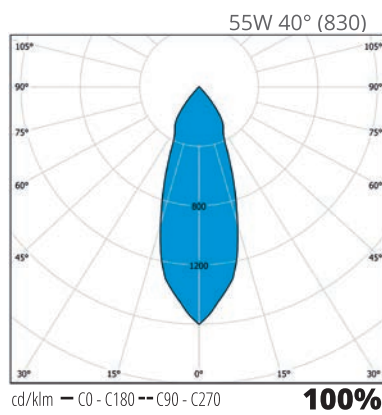
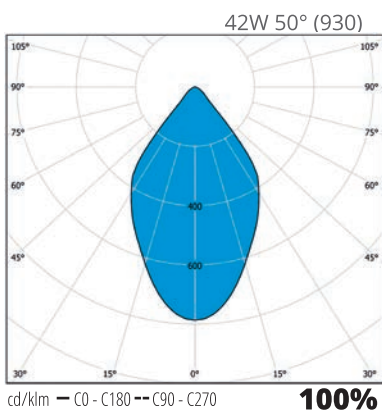
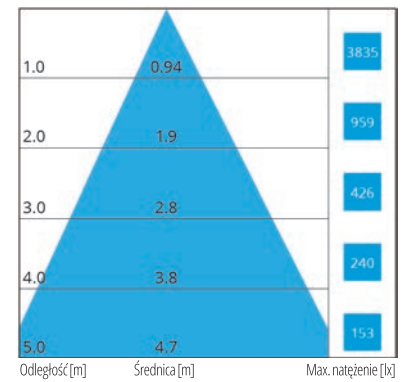
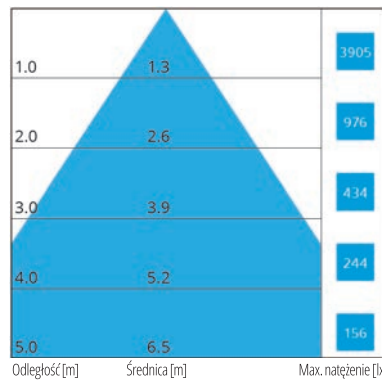
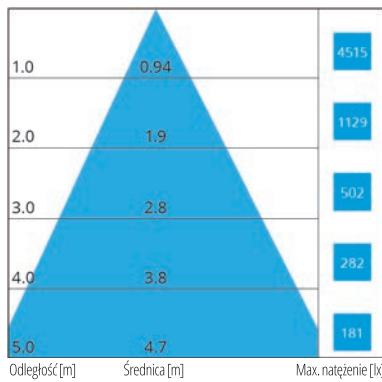
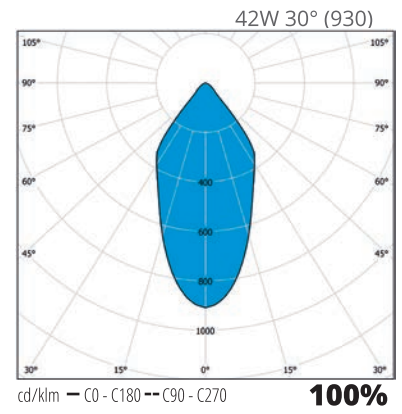
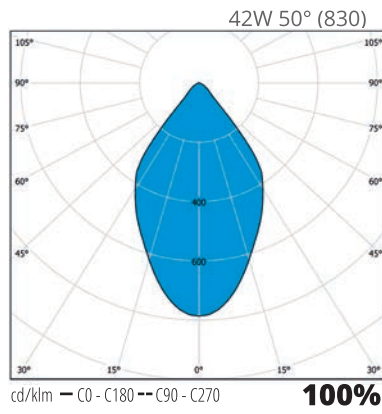
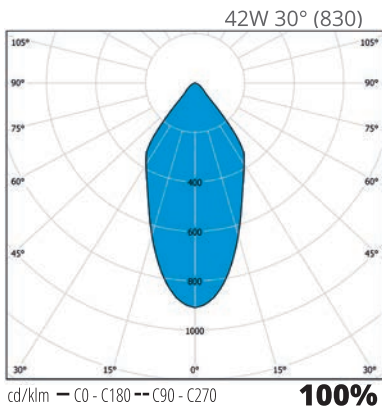

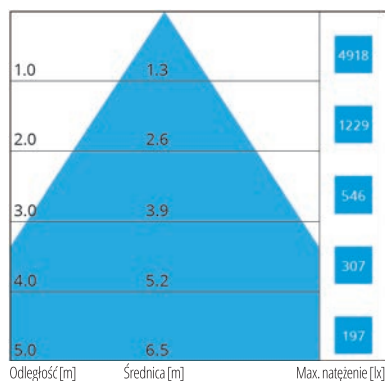
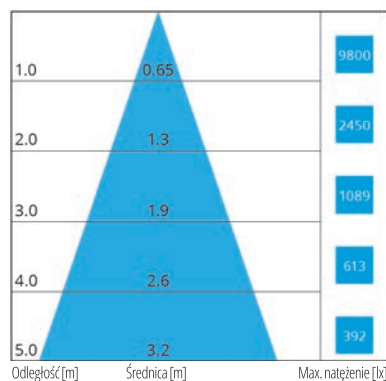
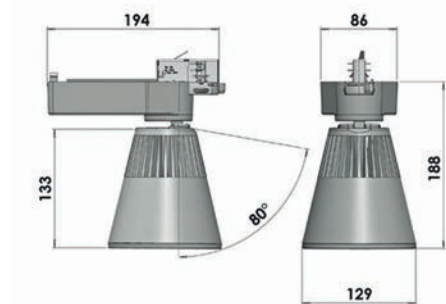
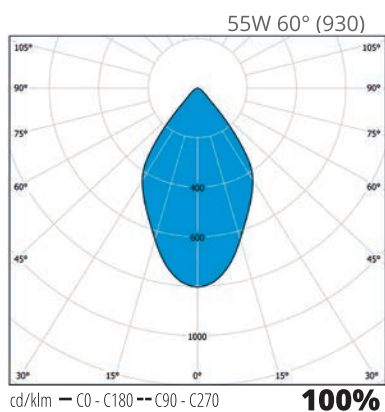
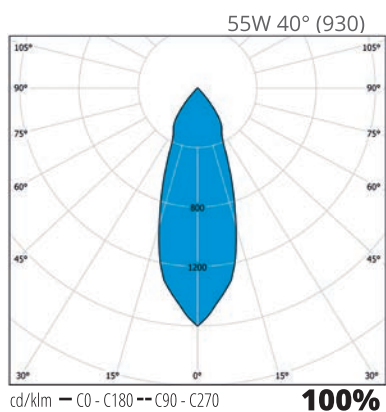

Diva

LED

Energooszczędna oprawa do oświetlenia punktowego.





Konstrukcja

- › Obudowa: malowane proszkowo aluminium
- › Kolory obudowy: biały i czarny
- › Moc: 34W
- › Kąt rozsyłu:
 - 30°
 - 50°
- › Strumień świetlny: patrz tabela
- › 3000 K i 4000 K, Ra>80 i Ra>90
- › MacAdams 2-SDCM
- › Żywotność modułu LED: 50 000h (L80B10)

Montaż

- › Szynoprzewód 3-fazowy

Na zamówienie

- › Obudowa w kolorze srebrnym
- › DALI
- › Inne kąty rozsyłu
- › Inne temperatury barwowe, strumienie świetlne oraz współczynniki oddawania barw
- › Specjalne kolory do oświetlania artykułów spożywczych

| EAN | Typ | Nazwa produktu | Źródło | Kolor | Kg | Kąt rozsyłu | Moc | Strumień świetlny |
|-------------|-------------|---------------------------|--------|--------|------|-------------|-----|-------------------|
| Diva | | | | | | | | |
| 42 605 13 | DI32FL830WH | DI32FL830WH 3175LM FL WH | LED | Biały | 0,57 | 30° | 34W | 3175 lm |
| 42 605 14 | DI32FL830BL | DI32FL830BL 3175LM FL BL | LED | Czarny | 0,57 | 30° | 34W | 3175 lm |
| 42 605 15 | DI31WF830WH | DI31WF830WH 3050LM WFL WH | LED | Biały | 0,57 | 50° | 34W | 3050 lm |
| 42 605 16 | DI31WF830BL | DI31WF830BL 3050LM WFL BL | LED | Czarny | 0,57 | 50° | 34W | 3050 lm |
| 42 605 17 | DI29FL930WH | DI29FL930WH 2925LM FL WH | LED | Biały | 0,57 | 30° | 34W | 2925 lm |
| 42 605 92 | DI31FL940WH | DI31FL940WH 3110LM FL WH | LED | Biały | 0,57 | 30° | 34W | 3110 lm |
| 42 605 18 | DI29FL930BL | DI29FL930BL 2925LM FL BL | LED | Czarny | 0,57 | 30° | 34W | 2925 lm |
| 42 605 19 | DI28WF930WH | DI28WF930WH 2785LM WFL WH | LED | Biały | 0,57 | 50° | 34W | 2785 lm |
| 42 605 20 | DI28WF930BL | DI28WF930BL 2785LM WFL BL | LED | Czarny | 0,57 | 50° | 34W | 2785 lm |



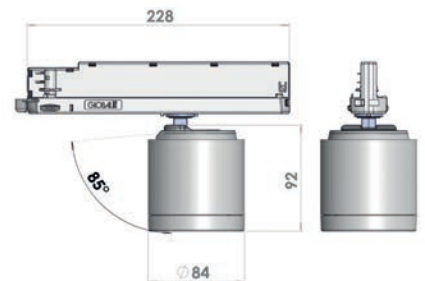
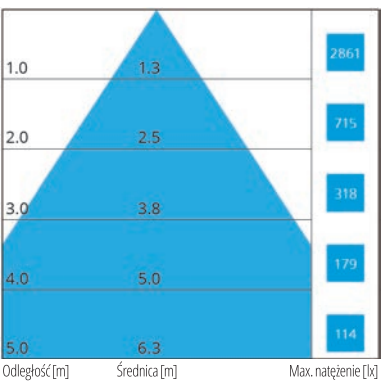
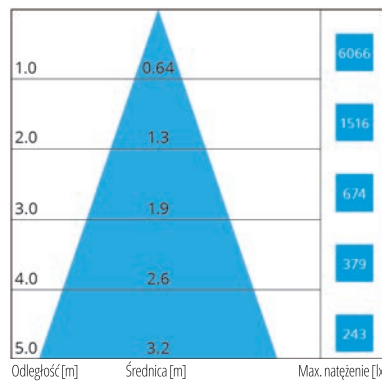
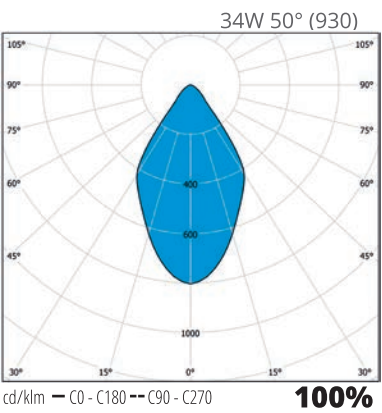
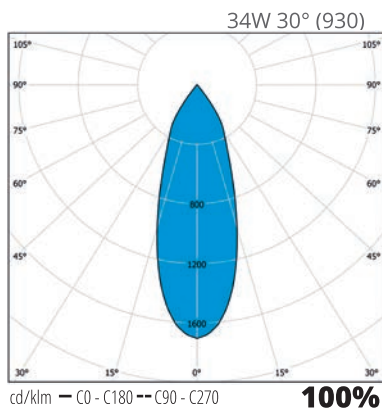
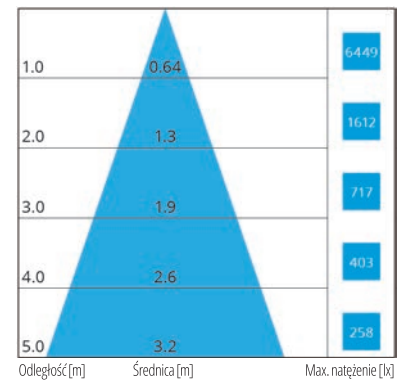
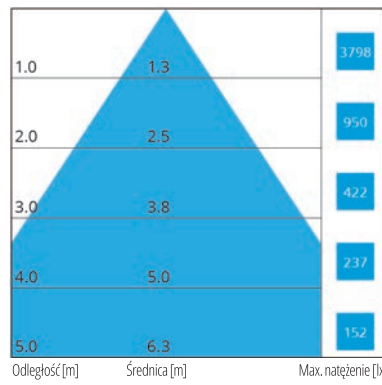
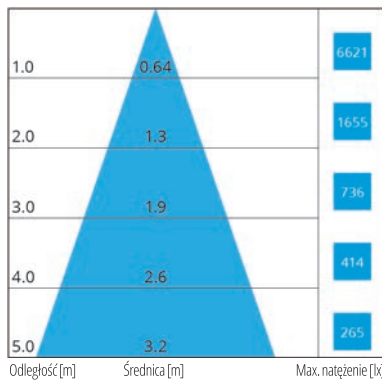
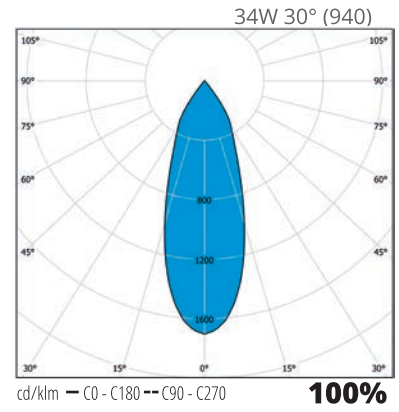
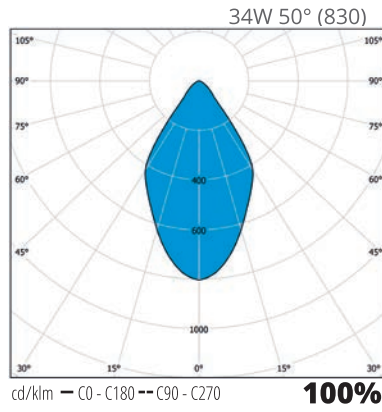
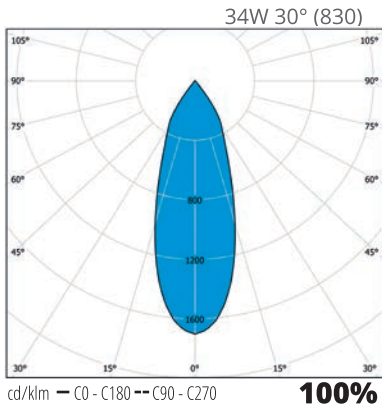



Club

LED

Energooszczędna oprawa do oświetlenia punktowego.





Konstrukcja

- › Obudowa: malowane proszkowo aluminium
- › Kolory obudowy: biały i czarny
- › Moc: 42W
- › Kąt rozsyłu:
 - 30°
 - 50°
- › Strumień świetlny: patrz tabela
- › 3000 K, 4000 K, Ra>80 i Ra>90
- › MacAdams 2-SDCM
- › Żywotność modułu LED: 50 000h (L80B10)

Montaż

- › Szynoprzewód 3-fazowy
- › Adapter GA69

Na zamówienie

- › Obudowa w kolorze srebrnym
- › DALI
- › Inne kąty rozsyłu
- › Inne temperatury barwowe, strumienie świetlne oraz współczynniki oddawania barw
- › Specjalne kolory do oświetlania artykułów spożywczych

| EAN | Typ | Nazwa produktu | Źródło | Kolor | Kg | Kąt rozsyłu | Moc | Strumień świetlny |
|-----------|-------------|---------------------------|--------|--------|------|-------------|-----|-------------------|
| Club | | | | | | | | |
| 42 605 21 | CL39FL830WH | CL39FL830WH 3875LM FL WH | LED | Biały | 1,06 | 30° | 42W | 3875 lm |
| 42 605 23 | CL39FL830BL | CL39FL830BL 3875LM FL BL | LED | Czarny | 1,06 | 30° | 42W | 3875 lm |
| 42 605 25 | CL37WF830WH | CL37WF830WH 3700LM WFL WH | LED | Biały | 1,06 | 50° | 42W | 3700 lm |
| 42 605 26 | CL37WF830BL | CL37WF830BL 3700LM WFL BL | LED | Czarny | 1,06 | 50° | 42W | 3700 lm |
| 42 605 27 | CL34FL930WH | CL34FL930WH 3375LM FL WH | LED | Biały | 1,06 | 30° | 42W | 3375 lm |
| 42 605 29 | CL34FL930BL | CL34FL930BL 3375LM FL BL | LED | Czarny | 1,06 | 30° | 42W | 3375 lm |
| 42 605 30 | CL32WF930WH | CL32WF930WH 3225LM WFL WH | LED | Biały | 1,06 | 50° | 42W | 3225 lm |
| 42 605 32 | CL32WF930BL | CL32WF930BL 3225LM WFL BL | LED | Czarny | 1,06 | 50° | 42W | 3225 lm |



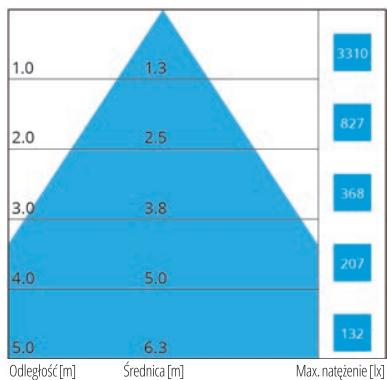
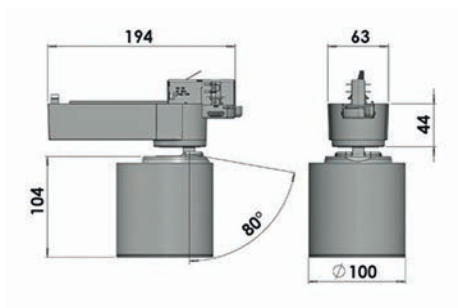
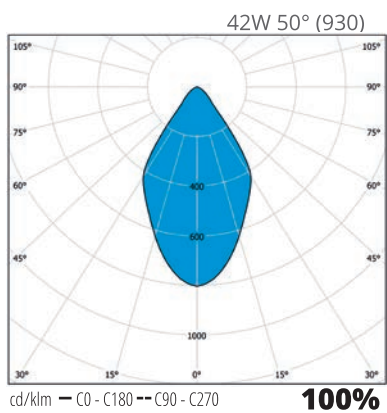
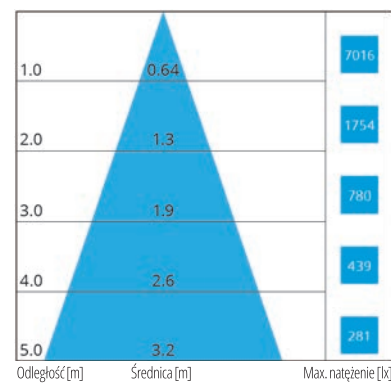
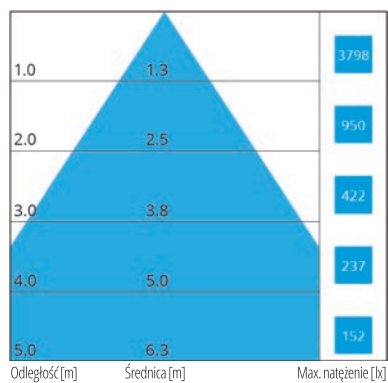
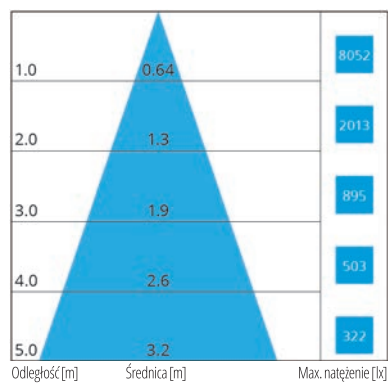
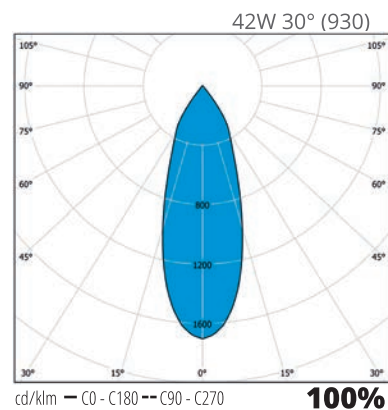
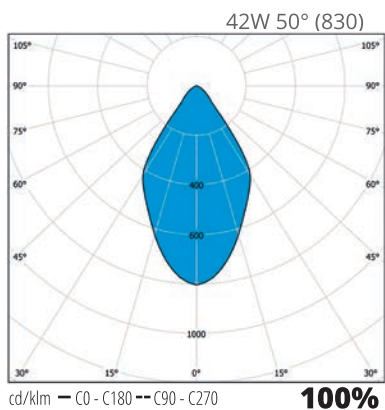
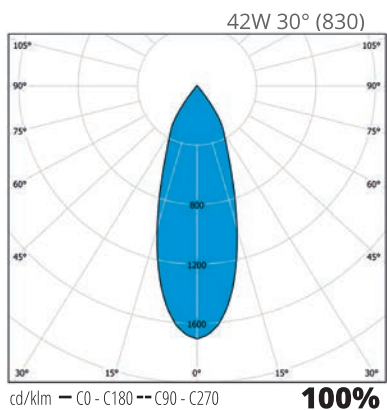



Play

LED



Wszechstronny i energooszczędny
downlight do ogólnego oświetlenia
w sklepach i biurach. Kąt pochylenia
90°.



Konstrukcja

- › Obudowa: malowane proszkowo aluminium
- › Kolory obudowy: biały
- › Moc: 42W i 55W
- › Kąt rozsyłu:
 - 30° i 50° (42W)
 - 40° i 60° (55W)
- › Strumień świetlny: patrz tabela
- › 3000 K, 4000 K, Ra>80 i Ra>90
- › MacAdams 2-SDCM
- › Żywotność modułu LED: 50 000h (L80B10)

Montaż

- › Montaż wpuszczany
- › Zasilacz zewnętrzny, długość przewodu 1 metr

Na zamówienie

- › Obudowa w kolorze srebrnym lub czarnym
- › DALI
- › Inne kąty rozsyłu
- › Inne temperatury barwowe, strumienie świetlne oraz współczynniki oddawania barw
- › Specjalne kolory do oświetlania artykułów spożywczych
- › 2,5 m przewód zasilający z wtyczką Schuko

| EAN | Typ | Nazwa produktu | Źródło | Kolor | Kg | Kąt rozsyłu | Moc | Strumień świetlny |
|-----------|-------------|------------------------------|--------|--------|------|-------------|-----|-------------------|
| Play | | | | | | | | |
| 42 605 33 | PL39FL830WH | PL39FL830WH 3900LM FL WH 1M | LED | Biały | 1,55 | 30° | 42W | 3900 lm |
| 42 605 36 | PL39FL830BL | PL39FL830BL 3900LM FL BL 1M | LED | Czarny | 1,55 | 30° | 42W | 3900 lm |
| 42 605 39 | PL40WF830WH | PL40WF830WH 3975LM WFL WH 1M | LED | Biały | 1,55 | 50° | 42W | 3975 lm |
| 42 605 40 | PL40WF830BL | PL40WF830BL 3975LM WFL BL 1M | LED | Czarny | 1,55 | 50° | 42W | 3975 lm |
| 42 605 42 | PL33FL930WH | PL33FL930WH 3300LM FL WH 1M | LED | Biały | 1,55 | 30° | 42W | 3300 lm |
| 42 605 43 | PL33FL930BL | PL33FL930BL 3300LM FL BL 1M | LED | Czarny | 1,55 | 30° | 42W | 3300 lm |
| 42 605 55 | PL34WF930WH | PL34WF930WH 3375LM WFL WH 1M | LED | Biały | 1,55 | 50° | 42W | 3375 lm |
| 42 605 64 | PL34WF930BL | PL34WF930BL 3375LM WFL BL 1M | LED | Czarny | 1,55 | 50° | 42W | 3375 lm |
| 42 605 74 | PL59FL830WH | PL59FL830WH 5850LM FL WH 1M | LED | Biały | 1,65 | 40° | 55W | 5850 lm |
| 42 605 75 | PL59FL830BL | PL59FL830BL 5850LM FL BL 1M | LED | Czarny | 1,65 | 40° | 55W | 5850 lm |
| 42 605 76 | PL59WF830WH | PL59WF830WH 5875LM WFL WH 1M | LED | Biały | 1,65 | 60° | 55W | 5875 lm |
| 42 605 77 | PL59WF830BL | PL59WF830BL 5875LM WFL BL 1M | LED | Czarny | 1,65 | 60° | 55W | 5875 lm |
| 42 605 78 | PL50FL930WH | PL50FL930WH 5000LM FL WH 1M | LED | Biały | 1,65 | 40° | 55W | 5000 lm |
| 42 605 80 | PL50FL930BL | PL50FL930BL 5000LM FL BL 1M | LED | Czarny | 1,65 | 40° | 55W | 5000 lm |
| 42 605 81 | PL50WF930WH | PL50WF930WH 5025LM WFL WH 1M | LED | Biały | 1,65 | 60° | 55W | 5025 lm |
| 42 605 82 | PL50WF930BL | PL50WF930BL 5025LM WFL WH 1M | LED | Czarny | 1,65 | 60° | 55W | 5025 lm |

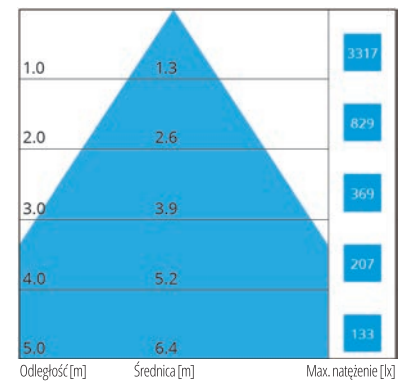
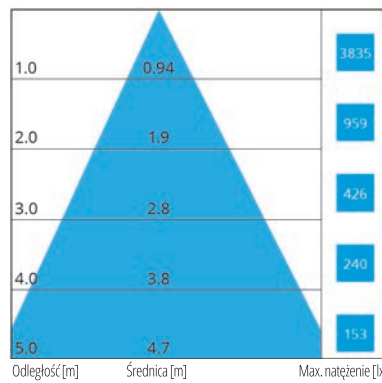
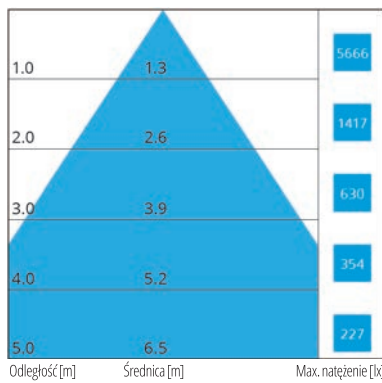
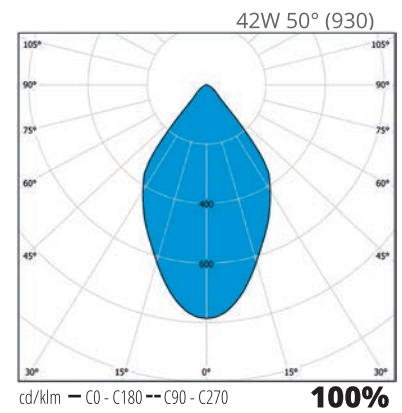
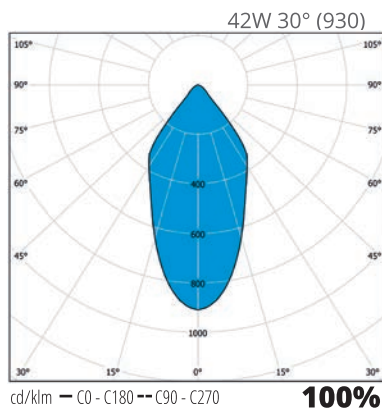
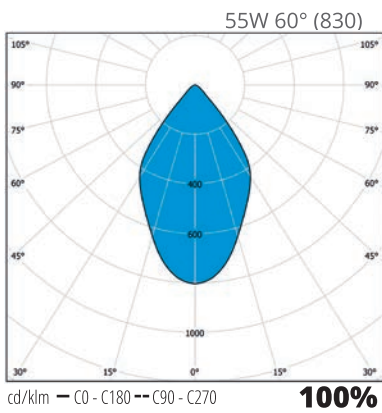
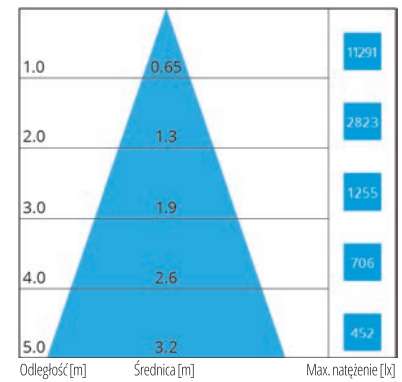
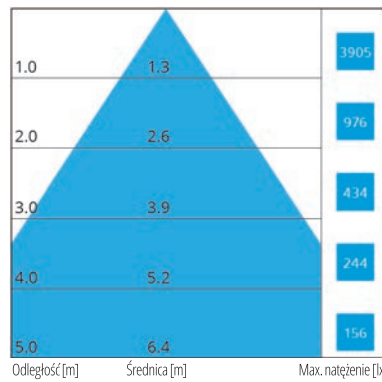
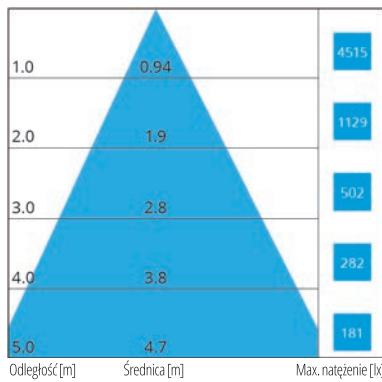
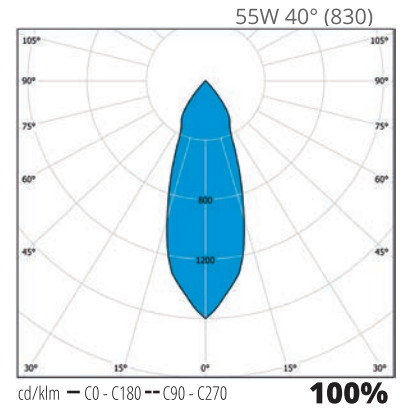
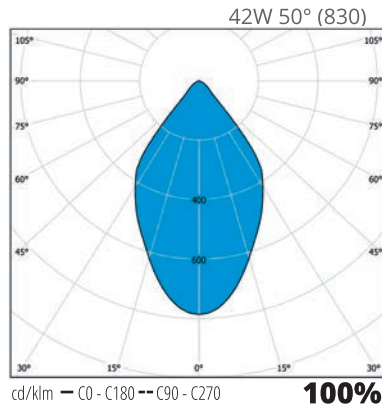
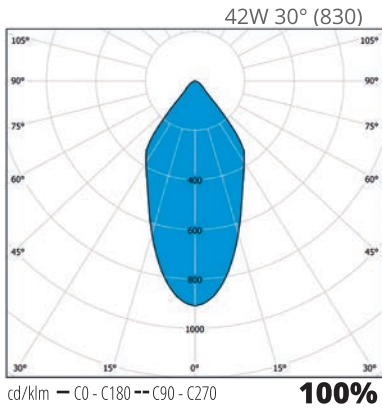

55W 40° (930)

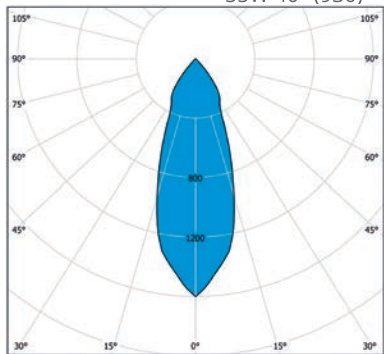

cd/klm — C0 - C180 — C90 - C270 **100%**

55W 60° (930)

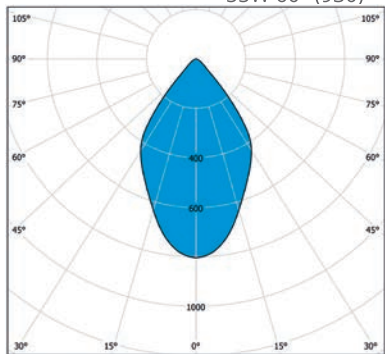

cd/klm — C0 - C180 — C90 - C270 **100%**

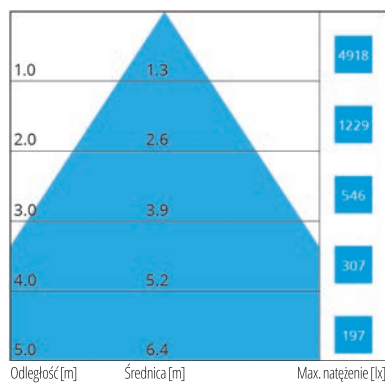
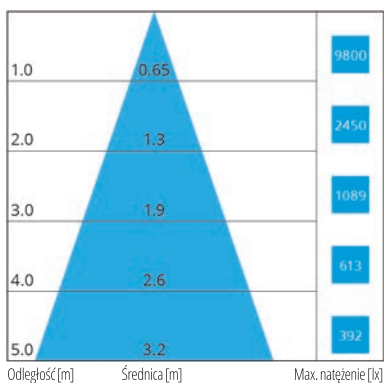
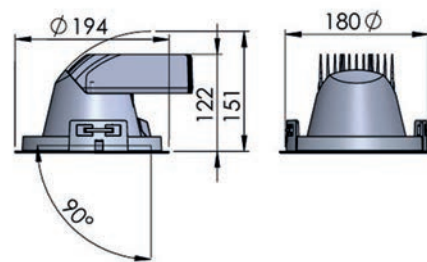

Mini Play

LED



Kompaktowy downlight do oświetlenia ogólnego w sklepach i biurach. Kąt pochylenia 90°.



Konstrukcja

- › Obudowa: malowane proszkowo aluminium
- › Kolory obudowy: biały
- › Moc: 36W
- › Kąt rozsyłu: 30° i 50°
- › Strumień świetlny: patrz tabela
- › 3000 K, 4000, Ra>90
- › MacAdams 2-SDCM
- › Żywotność modułu LED: 50 000h (L80B10)

Montaż

- › Montaż wpuszczany
- › Zasilacz zewnętrzny, długość przewodu 1 metr

Na zamówienie

- › Obudowa w kolorze srebrnym lub czarnym
- › DALI
- › Inne kąty rozsyłu
- › Inne temperatury barwowe, strumienie świetlne oraz współczynniki oddawania barw
- › Specjalne kolory do oświetlania artykułów spożywczych
- › 2,5 m przewód zasilający z wtyczką Schuko

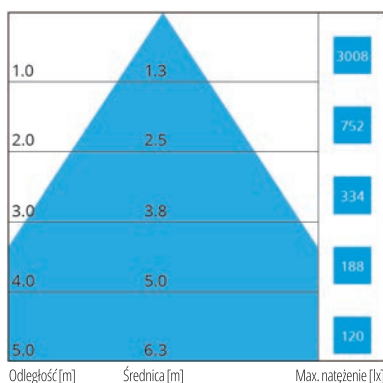
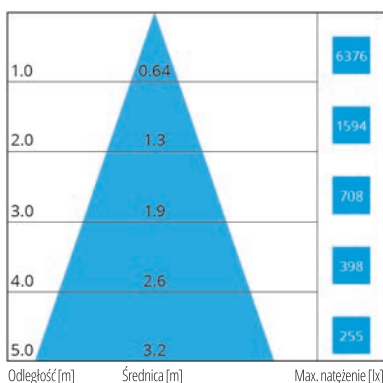
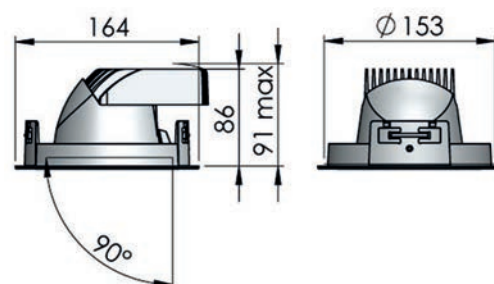
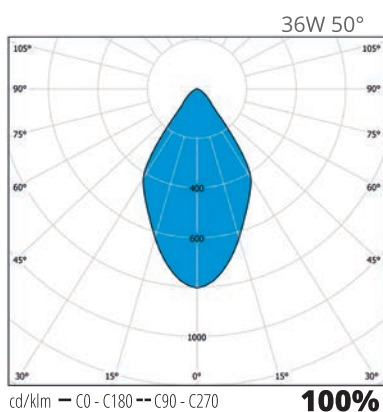
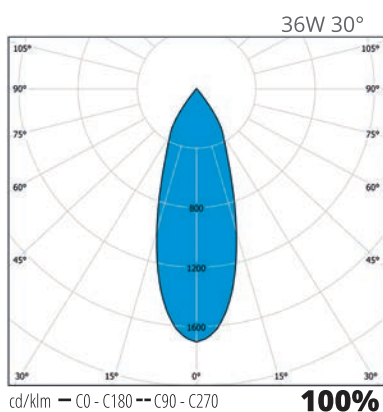

| EAN | Typ | Nazwa produktu | Źródło | Kolor | Kg | Kąt rozsyłu | Moc | Strumień świetlny |
|------------------|--------------|-------------------------------|--------|-------|------|-------------|-----|-------------------|
| Mini Play | | | | | | | | |
| 42 605 83 | MPL31FL930WH | MPL31FL930WH 3075LM FL WH 1M | LED | Biały | 1,08 | 30° | 36W | 3075 lm |
| 42 605 90 | MPL29WF930WH | MPL29WF930WH 2925LM WFL WH 1M | LED | Biały | 1,08 | 50° | 36W | 2925 lm |



ENSTO

Ensto Pol Sp. z o.o
ul. Starogardzka 17 A
83-010 Straszyn
biuro@ensto.com
Tel. +58 692 40 00
Fax +58 692 40 20

ensto.pl

