

Céliane™

Connected switch without neutral with dimmer option

Cat. Nos: 0 677 21/71 - 0 648 91

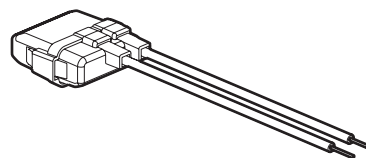
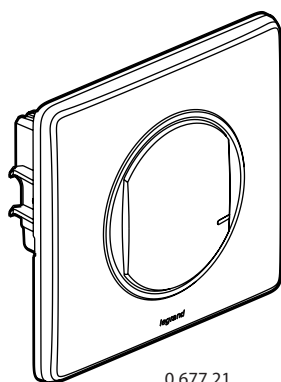

0 401 49

1. USE

Connected switch without neutral with dimmer option, configured by default as ON/OFF.
 Can be combined with one or more wireless lighting controls (dimmer mode can be activated from the Home + Control app).
 For local or remote control of your lighting.
 Supplied with an active power compensator (Cat. No. 0 401 49), mandatory to ensure optimum operation with commercially-available lamps. One compensator per lighting circuit is sufficient.
 Easy to install in place of a standard switch in a box 40 mm deep (minimum).
 Claw and/or screw fixing.

2. RANGE

Description	White	Titanium	Graphite
Product for use in conjunction with the starter pack. With LED indicator (configuration) and RESET button (hidden) used to return to factory settings. Supplied complete with claws and site protection covers.	0 677 21	0 677 71	0 648 91

3. DIMENSIONS (mm)

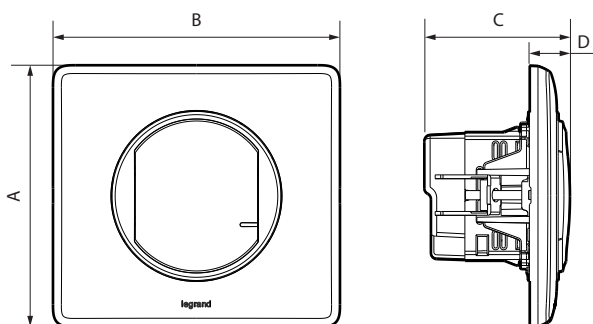

A	B	C	D
82	90	46	13

4. CONNECTION

Terminal type : screw
 Terminal capacity: 2 x 1.5 mm² or 2 x 2.5 mm²
 Stripping length:
 8 mm flat screwdriver: 3 mm

5. OPERATION

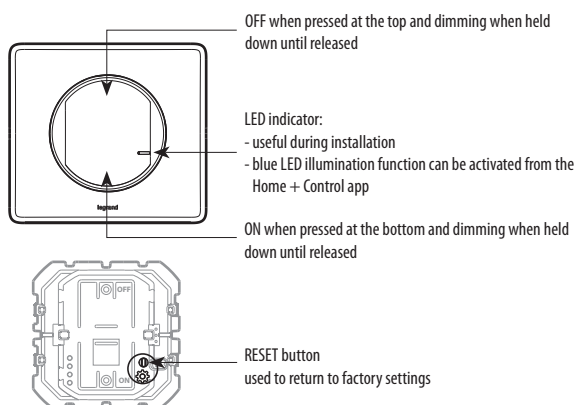

6. TECHNICAL CHARACTERISTICS

6.1 Mechanical characteristics

Protection against impacts: IK 04
 Protection against solid bodies/liquids: IP 41 assembled product

6.2 Material characteristics

Colour	White RAL 9003	Titanium	Graphite
Plate	ABS + PC	ABS + Metal	ABS + Metal
Rocker plate	ABS	Painted ABS	Painted ABS

Mechanism casing: PC
 Grid: 6.6 PA + Galfan steel
 Halogen-free
 UV-resistant
 Self-extinguishing:
 850°C/30 s for insulating parts holding live parts in place.
 650°C/30 s for the other insulating components.

6.3 Climate characteristics

Usage temperature: + 5°C to + 45°C
 Storage temperature: 0°C to + 45°C

Connected switch without neutral with dimmer option

6. TECHNICAL CHARACTERISTICS (continued)











■ 6.4 Electrical characteristics

Voltage: 110-230 V~

Power: 300 W

Frequency: 50/60 Hz

Standby consumption: 0.2 W

		R	L			
			LED 			
						
240 V~	Max.	300 W	(*50 W)	50 W	300 VA	300 VA
	Min.	7 W	5 W	9 W	10 VA	35 VA
100 V~	Max.	150 W	(*25 W)	25 W	150 VA	150 VA
	Min.	7 W	5 W	9 W	10 VA	35 VA

(*) Or 5 lamps max. For comfortable lighting, we recommend using bulbs of the same type and make.

(**) The ferromagnetic transformers must be charged to more than 60% of their power. When calculating the permissible power, the ferromagnetic transformer efficiency must be taken into account. A load must be connected before programming and using the product.

Zigbee technology 2.4 GHz to 2.4835 GHz

Power level: < 100 mW

Range: 200 m of unobstructed space

10 m between products indoors

7. CARE

Clean the surface with a cloth.

Do not use acetone, tar-removing cleaning agents or trichloroethylene.

Resistant to the following products: Hexane (EN 60669-1), methylated spirit, soapy water, diluted ammonia, bleach diluted to 10%, window-cleaning products, pre-impregnated wipes.

Caution: Always test before using special cleaning products.

The plates must not be painted.

8. ACCESSORIES

Replacement rocker plate: 0 648 15: White

0 648 25: Titanium

0 648 35: Graphite

9. STANDARDS AND APPROVALS

Compliant with installation and manufacturing standards.

See e-catalogue.

The undersigned, LEGRAND, declares that the radio-electric equipment type (0 677 21/71 - 0 648 91) complies with directive 2014/53/EU.

The full text of the EU declaration of conformity is available on the following website: www.legrandoc.com